

GE  
Energy

# Jenbacher Gasmotoren

## Ukraine: Erfahrungsbericht

Alex Pavlov, Wien, 06.03.2007



GE imagination at work

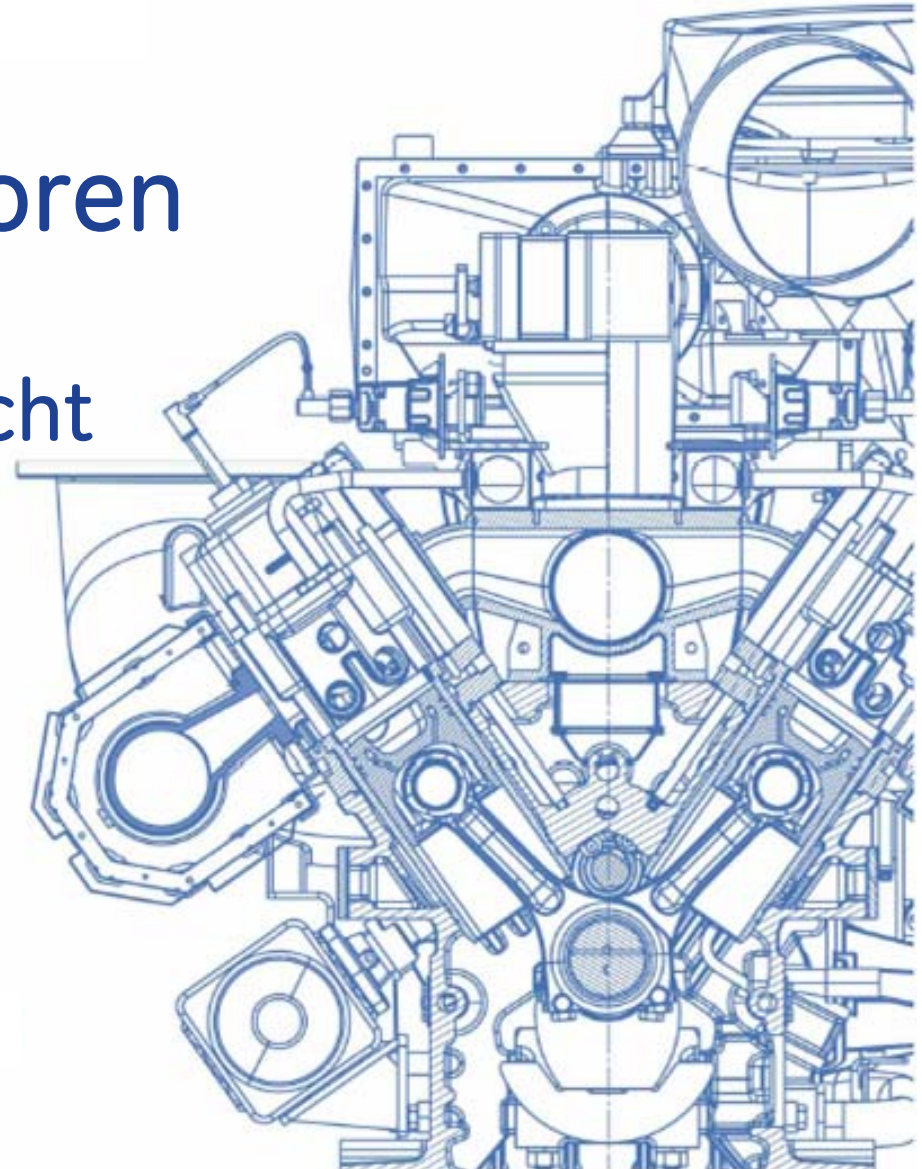

# GE – unsere Performance in Mrd. \$

<b>GE</b>	<b><u>2005</u></b>
Umsatz	149,7
Nettogewinn	18,3
Cash Flow/Operations	21,6
bezahlte Dividende	9,4

<b>GE Infrastructure</b>	<b><u>2005</u></b>
Umsatz	41,8
Nettogewinn	7,7

<b>Energy</b>	<b><u>2005</u></b>
Umsatz	16,5
Nettogewinn	2,6



# Hauptsitz



Jenbach, Montagehalle 2

**Die Gasmotorensparte von GE hat rund 1.200 der weltweit mehr als 1.400 Mitarbeiter in Jenbach, Österreich stationiert.**



GE imagination at work

# GE – unser Ansehen

2004

World's Most Respected Companies  
(#1) zum 7. Mal in Folge.  
*Financial Times*

**FINANCIAL TIMES**

2004

Global Most Admired Companies (#2).  
*Fortune*

**FORTUNE**

2004

In den Dow Jones Sustainability Index  
aufgenommen



2006

America's and World's Most Admired  
Companies (#1). *Fortune*



GE imagination at work

# Jenbacher Gasmotoren

## Führender Hersteller von Gasmotoren zur Energieversorgung.

- Leistungsbereich von 0,25 MW bis 3 MW  
Flexibel in der Gasanwendung: Erdgas bzw. verschiedenste erneuerbare oder alternative Gase (z.B.: Deponiegas, Biogas, Grubengas)
- Anlagenkonfigurationen:  
Gen-Sets, Blockheizkraftwerke (BHKW), Containerlösungen
- Installierte Größen: 6.000 Einheiten / 7.000 MW

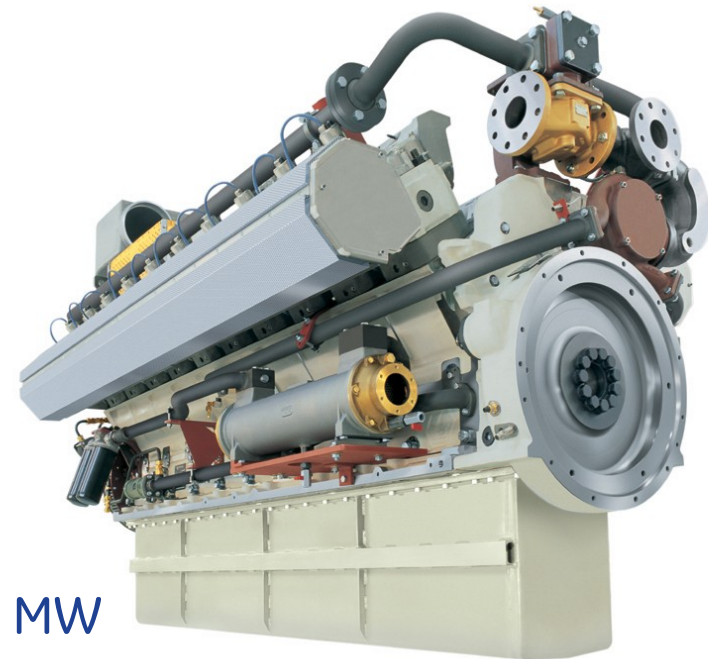

GE imagination at work

# Hauptanwendungen



**Kraft-Wärme-Kälte-Kopplung**



**Kraft-Wärme-Kopplung**



**CO<sub>2</sub>-Düngung**



GE imagination at work

# Hauptanwendungen für Biogas und Sondergase



**Biogas**

**ecomagination**  
a GE commitment



**Deponiegas**

**ecomagination**  
a GE commitment

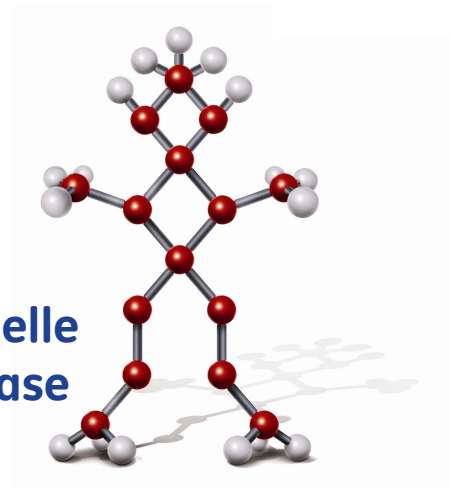

**Industrielle  
Abfallgase**

**Grubengas**

**ecomagination**  
a GE commitment



GE imagination at work

# Ukraine: aktuelle Eckdaten

BIP-Wachstum 2007: ca. 6%

Investitionen: 50% Maschinenbau & Industrie

10% Finanzdienstleistungssektor

15% Lebensmittelbereich

Industrie: Ostukraine

Pay-back für BHKW: 3-5 Jahre



GE imagination at work

# Ukraine: Ausgangsposition

Bis 2002: 0 MWel. verkauft

2002-2006: >80 MWel. verkauft

2007-2010: weiteres Potenzial >100 MW



GE imagination at work

# 2002-2006: Market drivers/barriers für BHKW

## DRIVERS

Niedrige Gaspreise

Unabhängigkeit von dem lokalen Stromnetz

Industriewachstum

## BARRIERS

Stromverkauf gesetzlich nicht geregelt

Billiger Strom vom Netz

Hohe Investitionen

Eigentum nicht gesichert



GE imagination at work

# 2007-2010: Market drivers/barriers für BHKW

## DRIVERS

Hohe Gas- und Strompreise

Kyoto-Protokoll

BHKW-Gesetz: Strom-, Wärmeverkauf möglich

Industriewachstum

## BARRIERS

begrenzte Finanzierungsmöglichkeiten

Politisches Risiko



GE imagination at work

# Stromerzeugung: Atom + Hydro= 60%

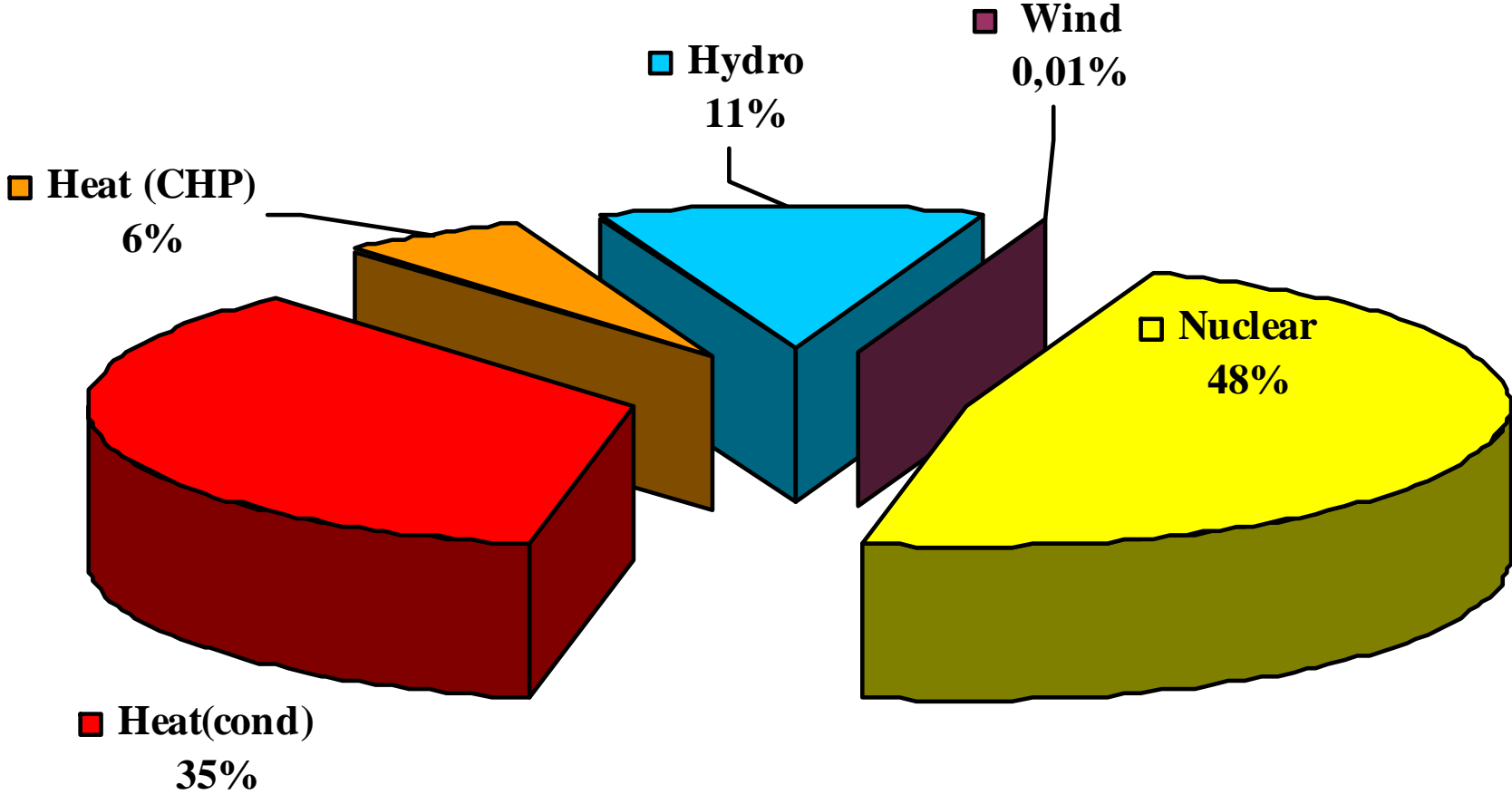

Quelle: Sinapse

# Strompreis: Juli 2006 in €cent ohne MwSt

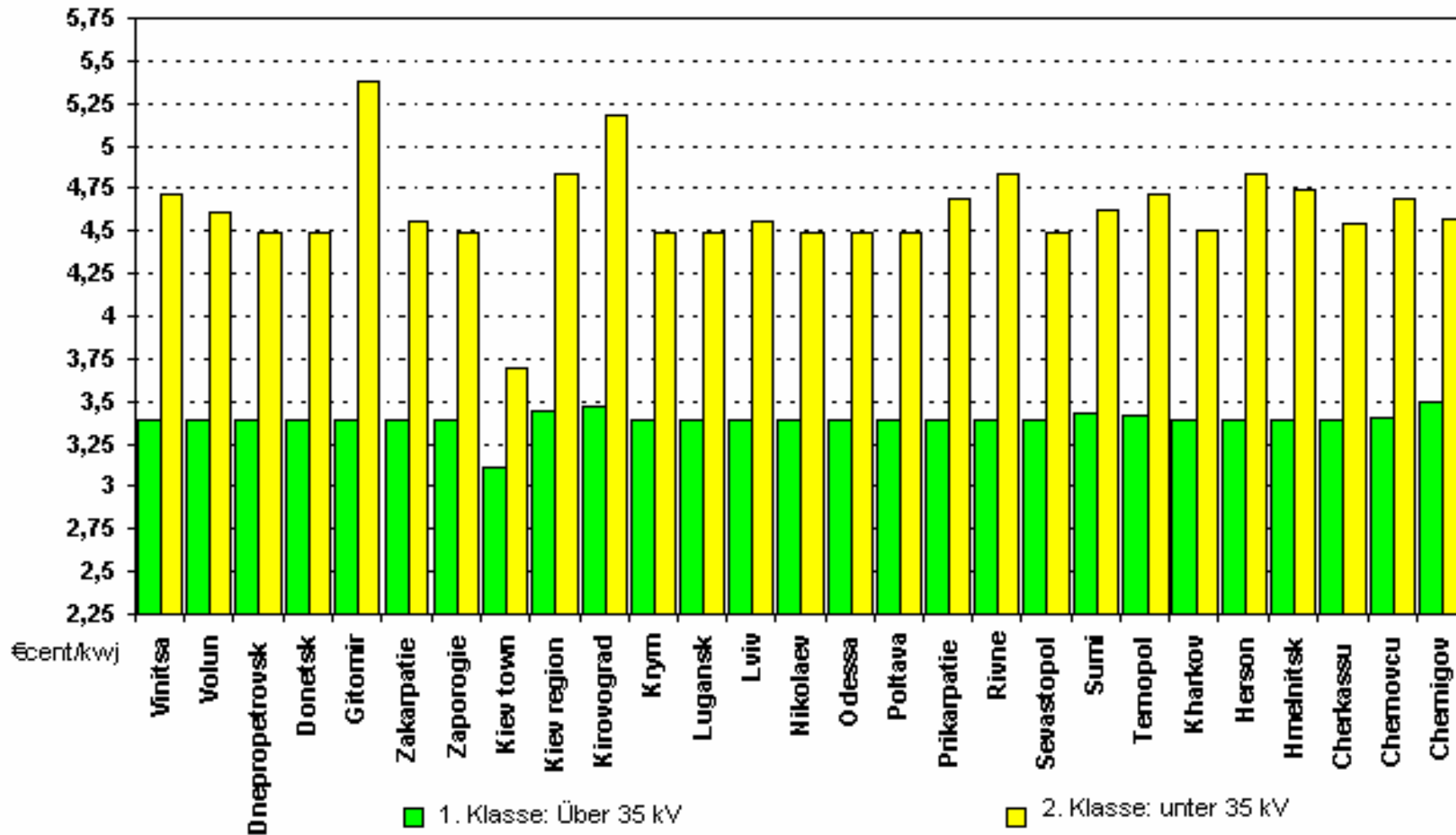

GE imagination at work

Quelle: Sinapse

# Strompreise 2002-2007

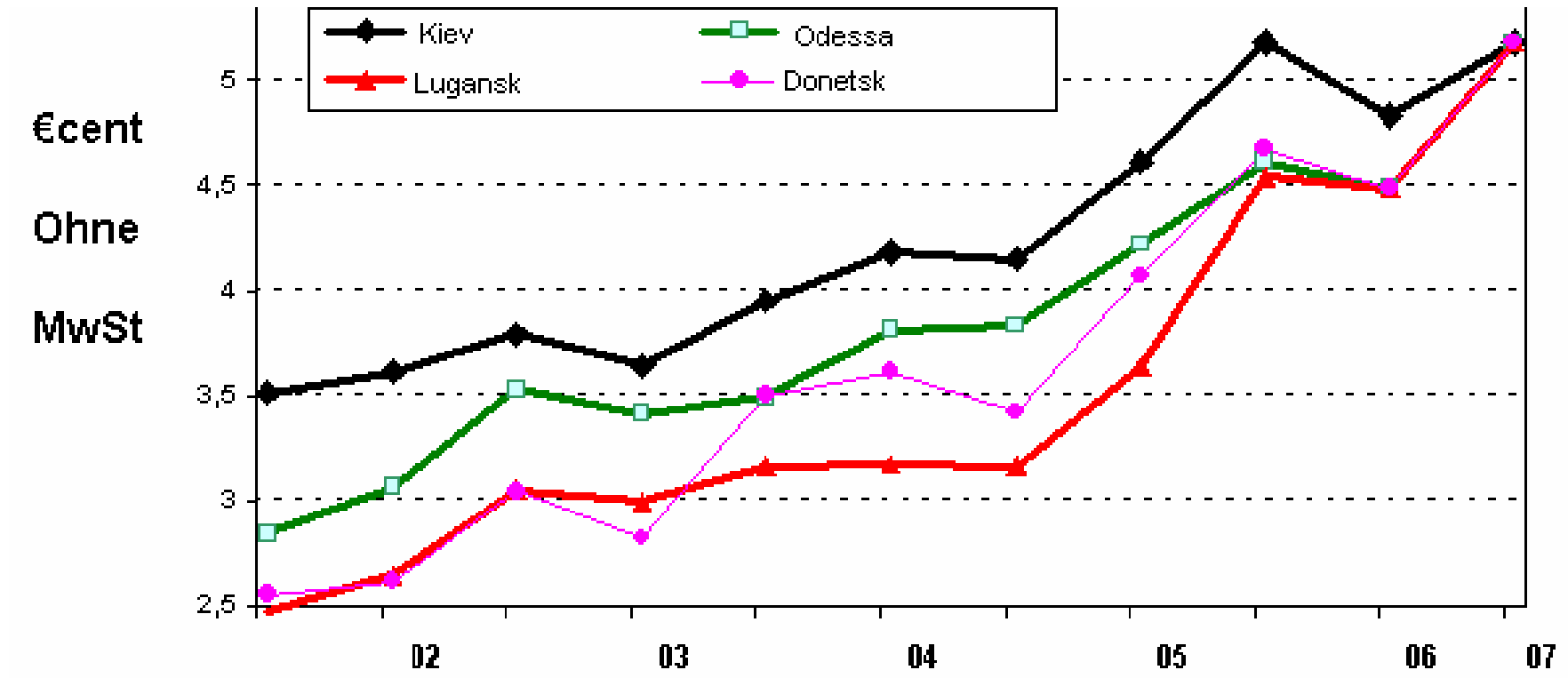

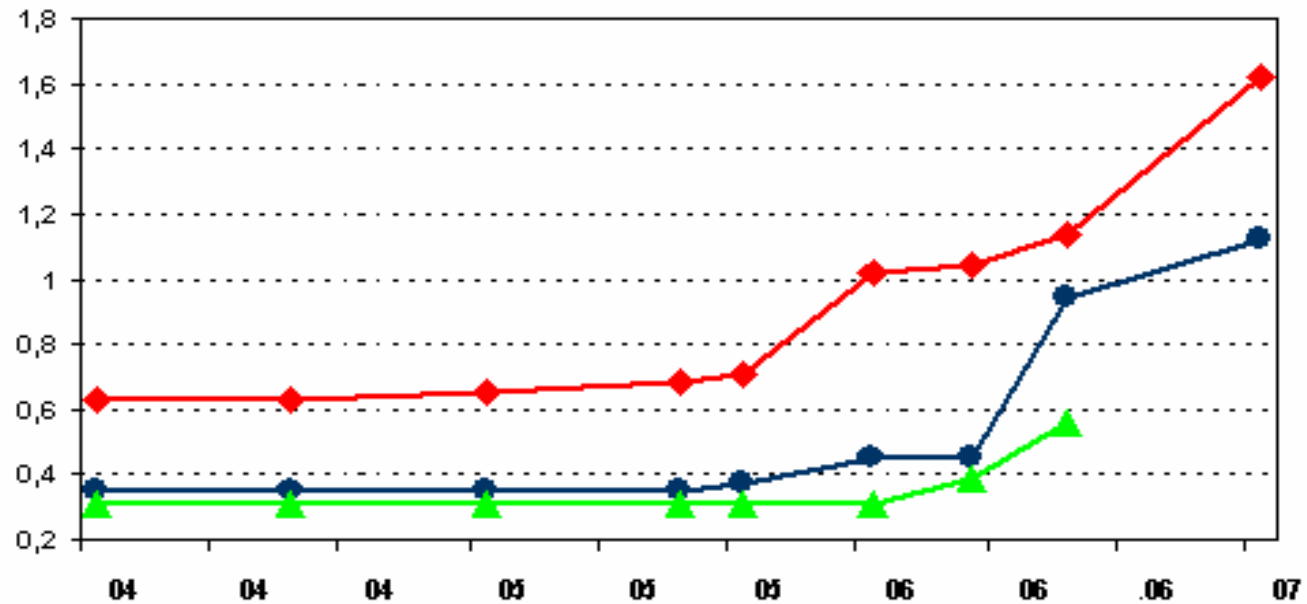

# Erdgaspreisentwicklung: 2004-2007

€cent pro  
1 nm3  
Erdgas



	0,63	0,63	0,65	0,68	0,71	1,02	1,04	1,14	1,62
	0,35	0,35	0,35	0,35	0,37	0,45	0,45	0,94	1,12
	0,31	0,31	0,31	0,31	0,31	0,31	0,39	0,56	

 **INDUSTRIE**       **FERNWÄRME**       **Bevölkerung**



GE imagination at work

Quelle: Sinapse

# Ukraine: weltweit größtes Grubengasprojekt



Grube Sasyadko

72 MW el.

66 MW th.



GE imagination at work

# Grubengas: 35-40.000 t CO<sub>2</sub>/ MW el pro Jahr



Erstes von der ukrainischen  
Regierung genehmigtes JI-Projekt



GE imagination at work

# Wichtige Erfahrungen

- Geschäfte mit Personen, nicht mit Unternehmen
- Lokaler Partner: entscheidende Rolle
- Hauptentscheidungskriterium ist der Preis
- Politik als wesentlicher Faktor
- Kurzfristige Ergebnisse sind von größerer Bedeutung
- Mentalitätsunterschiede: Ostukraine vs. Westukraine
- Ukraine als technischer Stützpunkt für GUS-Länder



GE imagination at work

Thank you...



...for your attention!



GE imagination at work

## Alex Pavlov

[alex.pavlov@ge.com](mailto:alex.pavlov@ge.com)

[www.gejenbacher.com](http://www.gejenbacher.com)

M: +43-676-8944-2655

T: +43-5244-600-2655

F: +43-5244-600-4-2655

GE Jenbacher GMBH & Co. OHG

Achenseestr. 1-3,

6200 Jenbach, AUSTRIA



GE imagination at work